



# Accessories for Lubrication

THK General Catalog

## A Product Descriptions

<b>Lubrication</b> .....	A24-2
Types of Lubricants .....	A24-2
• Grease Lubrication .....	A24-3
• Oil Lubrication .....	A24-3
Lubrication under Special Environments ..	A24-4
Lubrication Methods .....	A24-5
• Manual Lubrication .....	A24-5
• Forced Lubrication Method .....	A24-5
Lubrication Accessory Series for LM Systems ..	A24-6
• THK Original Grease .....	A24-6
AFA Grease .....	A24-7
AFB-LF Grease .....	A24-8
AFC Grease .....	A24-10
AFE-CA Grease .....	A24-12
AFF Grease .....	A24-14
AFG Grease .....	A24-18
AFJ Grease .....	A24-20
Grease Gun Unit MG70 .....	A24-24
Special Plumbing Fixtures .....	A24-25
Grease Nipple .....	A24-26
<b>Model No.</b> .....	A24-27
• Model Number Coding .....	A24-27

## B Support Book (Separate)

<b>Lubrication</b> .....	B24-2
Types of Lubricants .....	B24-2
• Grease Lubrication .....	B24-3
• Oil Lubrication .....	B24-3
Lubrication under Special Environments ..	B24-4
Lubrication Methods .....	B24-5
• Manual Lubrication .....	B24-5
• Forced Lubrication Method .....	B24-5
Lubrication Accessory Series for LM Systems ..	B24-6
• THK Original Grease .....	B24-6
AFA Grease .....	B24-7
AFB-LF Grease .....	B24-8
AFC Grease .....	B24-10
AFE-CA Grease .....	B24-12
AFF Grease .....	B24-14
AFG Grease .....	B24-18
AFJ Grease .....	B24-20
Grease Gun Unit MG70 .....	B24-24
Special Plumbing Fixtures .....	B24-24
Grease Nipple .....	B24-24
<b>Model No.</b> .....	B24-25
• Model Number Coding .....	B24-25

When using an LM system, it is necessary to provide effective lubrication. Without lubrication, the rolling elements or the raceway may be worn faster and the service life may be shortened.

A lubricant has effects such as the following.

- (1) Minimizes friction in moving elements to prevent seizure and reduce wear.
- (2) Forms an oil film on the raceway to decrease stress acting on the surface and extend rolling fatigue life.
- (3) Covers the metal surface to prevent rust formation.

To fully bring out an LM system's functions, it is necessary to provide lubrication according to the conditions.

It is necessary to study the mounting positions of the grease nipple and piping joint according to the installation direction.

(If the mounting orientation of the LM Guide is other than horizontal installation, the lubricant may not reach the raceway completely. Be sure to let THK know the installation direction and the exact position in each LM block where the grease nipple or the piping joint should be attached. For the mounting position of the LM Guide, see **A1-12**.)

Even with an LM system with seals, the internal lubricant gradually seeps out during operation. Therefore, the system needs to be lubricated at an appropriate interval according to the conditions.

## Types of Lubricants

LM systems mainly use grease or sliding surface oil for their lubricants.

The requirements that lubricants need to satisfy generally consist of the following.

- (1) High oil film strength
- (2) Low friction
- (3) High wear resistance
- (4) High thermal stability
- (5) Non-corrosive
- (6) Highly anti-corrosive
- (7) Minimal dust/water content
- (8) Consistency of grease must not be altered to a significant extent even after it is repeatedly stirred.

For lubricants that meet these requirements, see **A24-3**.

## Grease Lubrication

Greasing intervals vary depending on the conditions and environments. For normal use, we recommend greasing the system approximately every 100 km of travel distance.

Normally, replenish grease of the same group from the grease nipple or greasing hole provided on the LM system. Mixing different types of grease may deteriorate the system's performance, such as increased consistency.

Lubricant	Type	Brand name
Grease	Lithium-based grease (JIS No. 2) Urea-based grease (JIS No. 2)	AFA Grease (THK) see <a href="#">A24-7</a> AFB-LF Grease (THK) see <a href="#">A24-8</a> AFC Grease (THK) see <a href="#">A24-10</a> AFE-CA Grease (THK) see <a href="#">A24-12</a> AFF Grease (THK) see <a href="#">A24-14</a> AFG Grease (THK) see <a href="#">A24-18</a> AFJ Grease (THK) see <a href="#">A24-20</a>  Alvania Grease S No.2(Showa Shell Sekiyu) Eponex Grease No.2(Idemitsu) or equivalent

\*Recommended greases vary according to the conditions and environment. See [A24-6](#) to [A24-23](#) for details.

## Oil Lubrication

LM systems that require oil lubrication are shipped with only anti-rust oil applied. When placing an order, specify the required lubricant oil.

(If the installation direction of the LM Guide is other than horizontal installation, the lubricant may not reach the raceway completely. Be sure to let THK know the installation direction of the LM Guide.

For the mounting position of the LM Guide, see [A1-12](#).)

- The amount of oil to be supplied varies with stroke length. For a long stroke, increase the lubrication frequency or the amount of oil so that an oil film reaches the stroke end of the raceway.
- In environments where a liquid coolant is splattered, the lubricant will be mixed with the coolant, and this can result in the lubricant being emulsified or washed away, causing significantly degraded lubrication performance. In such settings, apply a lubricant with high viscosity (kinematic viscosity: approx. 68 cst) and high emulsification-resistant, and adjust the lubrication frequency or the amount of the feed lubricant.

For machine tools and similar devices that are subject to heavy loads and require high rigidity and operate at high speed, it is advisable to apply oil lubrication.

- Make sure that lubrication oil normally discharges from the ends of your lubrication piping, i.e., the oiling ports that connect to your LM system.

Lubricant	Type	Brand name
Oil	Sliding surface oil or turbine oil ISOVG32 to 68	Super Multi 32 to 68 (Idemitsu) Vactra No.2SLC (Exxon Mobil) DTE Oil (Exxon Mobil) Tonna Oil S (Showa Shell Sekiyu) or equivalent

## Lubrication under Special Environments

For use under special conditions, such as continual vibrations, clean room, vacuum, low temperature and high temperature, normal grease may not be used in some cases. For lubricants that meet such conditions, contact THK.

Table1 Lubricants Used under Special Environments

Service environment	Lubricant characteristics	Brand name
High-speed moving parts	Grease with low torque and low heat generation	AFG Grease (THK) see <a href="#">A24-18</a> AFA Grease (THK) see <a href="#">A24-7</a> AFJ Grease (THK) see <a href="#">A24-20</a> NBU15(NOK Kluba) Multemp (Kyodo Yushi) or equivalent
Vacuum	Fluorine based vacuum grease or oil (vapor pressure varies by brand) <small>Note 1</small>	Fomblin Y-VAC2/3 (Solvay) Demnum L-65/200 (Daikin Industries, Ltd) Barrierta IEL/V (NOK Kluba) Logenest lambda (Nippon Koyu)
Clean room	Grease with very low dust generation	AFE-CA Grease (THK) see <a href="#">A24-12</a> AFF Grease (THK) see <a href="#">A24-14</a>
Environments subject to microvibrations or microstrokes, which may cause fretting corrosion	Grease that easily forms an oil film and has high fretting resistance	AFC Grease (THK) see <a href="#">A24-10</a>
Environments subject to a spattering coolant such as machine tools	Highly anti-corrosive, refined mineral oil or synthetic oil that forms a strong oil film and is not easily emulsified or washed away by coolant Water-resistant grease <small>Note 2</small>	Super Multi 68 (Idemitsu) Vactra No.2SLC (Exxon Mobil) or equivalent

Note1) When using a vacuum grease, be sure that some brands have starting resistances several times greater than ordinary lithium-based greases.

Note2) In an environment subject to a spattering water-soluble coolant, some brands of intermediate viscosity significantly decrease their lubricity or do not properly form an oil film. Check the compatibility between the lubricant and the coolant.

Note3) Do not mix greases with different physical properties.

## Lubrication Methods

There are roughly three methods of lubricating LM systems: manual lubrication using a grease gun or manual pump; forced oiling with the aid of an automatic pump; and oil-bath lubrication.

To achieve efficient lubrication, it is necessary to mount the grease nipple or the piping joint according to the installation direction.

(If the installation direction of the LM Guide is other than horizontal installation, the lubricant may not reach the raceway completely. Be sure to let THK know the mounting orientation and the exact position in each LM block where the grease nipple or the piping joint should be attached. For the mounting position of the LM Guide, see **A1-12**.)

### Manual Lubrication

Generally, grease is replenished periodically, fed through a grease nipple provided on the LM system, using a grease gun. (Fig.1)

For systems that have many locations to be lubricated, establish a centralized piping system and periodically provide grease from a single point using a manual pump. (Fig.2)

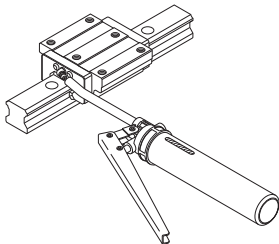

Fig.1 Lubrication Using a Grease Gun

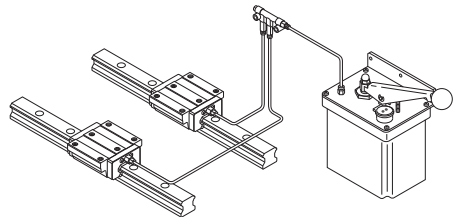

Fig.2 Lubrication through a Centralized Piping System

Note) When a centralized piping system is used, lubricant may not reach the pipe end due to the viscous resistance inside the pipe. Select the right type of grease while taking into account the consistency of the grease and the pipe diameter.

### Forced Lubrication Method

In this method, a given amount of lubricant is forcibly fed at a given interval. Normally, the lubricant is not collected after use. (Fig.3)

Although a special lubrication system using a piping or the like needs to be designed, this method reduces the likelihood of forgetting to replenish lubricant.

This method is used mainly for oil lubrication. If using grease, it is necessary to examine the appropriate piping diameter and the required grease consistency.

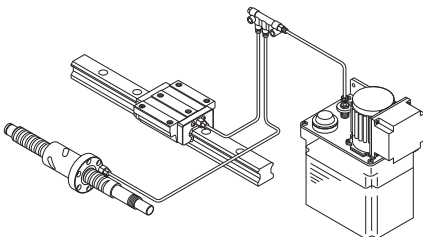

Fig.3 Forced Lubrication Method

# Lubrication Accessory Series for LM Systems

THK provides a wide array of lubrication accessories such as grease, grease guns, grease nipples and plumbing fixtures available for various applications. (A24-7 to A24-26)

## THK Original Grease

THK provides various types of THK original greases needed for the lubrication of LM systems. They are available for various conditions and environments.

### [Table for Grease Selection]

Refer to the table below that allows you to select a type of grease according to the application of the LM system. Also note that the color of the decorative package varies according to the type (both 70 g and 400 g).

Name of grease	AFA Grease	AFB-LF Grease	AFC Grease	AFE-CA Grease	AFF Grease	AFG Grease	AFJ Grease
Features	Low-Resistance grease	All-purpose grease	High-speed/micro-vibration grease	Grease for clean environment	Grease for clean environment	Grease for heat of Ball Screw	Grease suited to a wide range of speeds
Base oil	high-grade synthetic oil	refined mineral oil	high-grade synthetic oil	high-grade synthetic oil	high-grade synthetic oil	high-grade synthetic oil	refined mineral oil
Consistency enhancer	Urea-based	Lithium-based	Urea-based	Urea-based	Lithium-based	Urea-based	Urea-based
Industrial machinery	General industrial machinery	—	◎	—	—	—	—
	High Speed	◎	—	—	—	◎	○
	High Load	—	◎	—	—	—	—
Machine tool	General machine tools	—	◎	—	—	—	—
	High Speed	○	—	—	—	◎	○
	High acceleration/deceleration	—	—	—	—	—	◎
	Micro-vibration	—	—	◎	—	—	—
Semiconductor manufacturing equipment	General semiconductor fabrication equipment	—	◎	—	—	—	—
	High Speed	◎	—	—	—	○	○
	Micro-vibration	—	—	◎	—	○	—
	High acceleration/deceleration	—	—	—	—	—	◎
	Clean environments	—	—	—	◎	◎	—
Special environments	Low-resistance	◎	—	—	—	○	○
	Low heat generation	—	—	—	—	◎	—
	Wide range of speeds	—	—	—	—	—	◎
	Wide temperature range	—	—	◎	—	—	—
Color of decorative package	Green	Orange	Mazarine	Lime green	Light blue	Blue	Yellow
Reference page	A24-7	A24-8	A24-10	A24-12	A24-14	A24-18	A24-20

### Model number coding

•Type of packing···bellows cartridge

**AFC + 70**

Cartridge capacity (70 g / 400 g)

Type of grease (AFA Grease, AFB-LF Grease, AFC Grease, AFE-CA Grease, AFF Grease, AFG Grease, AFJ Grease)

## THK Original Grease

# AFA Grease

- Base oil: high-grade synthetic oil
- Consistency enhancer: urea-based



AFA Grease is a high-grade, long-life grease developed with a urea-based consistency enhancer using a high-grade synthetic oil as the base oil.

### [Features]

- Long service life**  
Unlike ordinary soap based grease for metal lubrication, AFA Grease excels in antioxidant stability and therefore can be used for a long period of time.
- Wide temperature range**  
The lubricating performance remains high over a wide range of temperatures from -45°C to +160°C.  
Even at low temperatures, AFA Grease requires only a low starting torque.
- High water resistance**  
AFA Grease is less vulnerable to moisture penetration than other types of grease because of its high water resistance.
- High mechanical stability**  
AFA Grease is not easily softened and demonstrates excellent mechanical stability even when used for a long period of time.

### [Representative Physical Properties]

Item	Representative value	Test method
Consistency enhancer	Urea-based	
Base oil	high-grade synthetic oil	
Base oil kinematic viscosity: mm <sup>2</sup> /s (40°C)	25	JIS K 2220 23
Worked penetration (25°C, 60W)	285	JIS K 2220 7
Mixing stability (100,000 W)	329	JIS K 2220 15
Dropping point °C	261	JIS K 2220 8
Evaporation amount: mass% (99°C, 22h)	0.2	JIS K 2220 10
Oil separation rate: mass% (100°C, 24h)	0.5	JIS K 2220 11
Copper plate corrosion (B method, 100°C, 24h)	Accepted	JIS K 2220 9
Low temperature torque: N·m (-20°C)	Start	170
	(revolutions)	70
4-ball testing (burn-in load): N	3089	ASTM D2596
Service Temperature Range °C	-45 to 160	
Color	Brown	

### [Rotation Torque Testing with Ball Screw Grease]

<Test method>

Apply 1 cc of grease to the LM Guide of KR4620A+640L and 2 cc to the Ball Screw (initial lubrication only), and then measure the torque at each motor rotation speed.

In torque measurement, output values on the driver torque monitor are used.

Comparative Table of Rotation Torque of Ball Screws by Grease

Unit: N·cm

Grease	Central value of dynamic viscosity CST (mm <sup>2</sup> /s)(40°C)	Dynamic viscosity range CST (mm <sup>2</sup> /s)(40°C)	Rotational speed			
			100min <sup>-1</sup>	1000min <sup>-1</sup>	2000min <sup>-1</sup>	4000min <sup>-1</sup>
AFA Grease	25	22.5 to 27.5	11.27	11.27	12.25	14.6
Grease of manufacturer I	130	117 to 143	14.6	23.13	31.16	43.12
Grease of manufacturer K	15.3	13.8 to 16.8	12.64	12.05	13.03	14.41
Lubricant VG32	32	28.8 to 35.2	11.17	10.78	13.43	14.7

Note) The values of the competitors' greases are that of low-torque greases.

## THK Original Grease

# AFB-LF Grease

- Base oil: refined mineral oil
- Consistency enhancer: lithium-based



AFB-LF Grease is a general-purpose grease developed with a lithium-based consistency enhancer using refined mineral oil as the base oil. It excels in extreme pressure resistance and mechanical stability.

### [Features]

- (1) High extreme pressure resistance  
Compared with lithium-based greases available on the market, AFB-LF Grease has higher wear resistance and outstanding resistance to extreme pressure.
- (2) High mechanical stability  
AFB-LF Grease is not easily softened and demonstrates excellent mechanical stability even when used for a long period of time.
- (3) High water resistance  
Compared with ordinary lithium grease, this product is a highly water resistant grease with minimal softening due to moisture penetration and very little deterioration under extreme pressures.
- (4) Long service life  
It provides many times the lubrication life of lithium soap-based greases. As a result, it offers a lower maintenance workload and greater economy due to the longer intervals between greasing.

### [Representative Physical Properties]

Item	Representative value	Test method
Consistency enhancer	Lithium-based	
Base oil	refined mineral oil	
Base oil kinematic viscosity: mm <sup>2</sup> /s (40°C)	170	JIS K 2220 23
Worked penetration (25°C, 60W)	275	JIS K 2220 7
Mixing stability (100,000 W)	345	JIS K 2220 15
Dropping point °C	193	JIS K 2220 8
Evaporation amount: mass% (99°C, 22h)	0.4	JIS K 2220 10
Oil separation rate: mass% (100°C, 24h)	0.6	JIS K 2220 11
Copper plate corrosion (B method, 100°C, 24h)	Accepted	JIS K 2220 9
Low temperature torque: N·m (-20°C)	Start	130
	(revolutions)	51
4-ball testing (burn-in load): N	3089	ASTM D2596
Service Temperature Range °C	-15 to 100	
Color	Yellowish brown	



**[Comparison of Grease Service Life Data]**

<Test products>

LM Guide HSR25CA1SS + 600L

<Test conditions>

Load : 9.8 kN/block

Stroke : 350mm

Speed : 30m/min (MAX)

Time constant : 200msec

Greasing quantity : 4g/block (initial lubrication only)

Travel distance until flaking occurs by grease type

Grease	Distance	(km)								
		0	100	200	300	400	500	600	700	
AFB-LF Grease										
Ordinary lithium-soap based grease										

## THK Original Grease

# AFC Grease

- Base oil: high-grade synthetic oil
- Consistency enhancer: urea-based



AFC Grease has high fretting-corrosion resistance due to a special additive and a urea-based consistency enhancer using a high-grade synthetic oil as the base oil.

### [Features]

- (1) High fretting-corrosion resistance  
AFC Grease is designed to be highly effective in preventing fretting corrosion.
- (2) Long service life  
Unlike ordinary soap based grease for metal lubrication, AFC Grease excels in antioxidant stability and therefore can be used for a long period of time. As a result, maintenance work is reduced.
- (3) Wide temperature range  
Since a high-grade synthetic oil is used as the base oil, the lubricating performance remains high over a wide range of temperatures from -54 °C to +177 °C.

### [Representative Physical Properties]

Item	Representative value	Test method
Consistency enhancer	Urea-based	
Base oil	high-grade synthetic oil	
Base oil kinematic viscosity: mm <sup>2</sup> /s (40°C)	25	JIS K 2220 23
Worked penetration (25°C, 60W)	288	JIS K 2220 7
Mixing stability (100,000 W)	341	JIS K 2220 15
Dropping point °C	269	JIS K 2220 8
Evaporation amount: mass% (99°C, 22h)	0.2	JIS K 2220 10
Oil separation rate: mass% (100°C, 24h)	0.6	JIS K 2220 11
Copper plate corrosion (B method, 100°C, 24h)	Accepted	JIS K 2220 9
Low temperature torque: N·m (-20°C)	Start	JIS K 2220 18
	(revolutions)	
4-ball testing (burn-in load): N	3089	ASTM D2596
Service Temperature Range °C	-54 to 177	
Color	Brown	

### [Test Data on Fretting-corrosion Resistance]

#### ● Test Data on AFC Grease (Comparison of Raceway Conditions)

The test data in the figure shows the results of comparing this product with an ordinary bearing grease.

<Test conditions>

Item	Description
Stroke	3mm
Number of strokes per minute	200min <sup>-1</sup>
Total number of strokes	2.88 × 10 <sup>5</sup> (24 hours)
Surface pressure	1118MPa
Grease quantity	12g/1LM block (replenished every 8 hours)

#### AFC Grease

Before travel

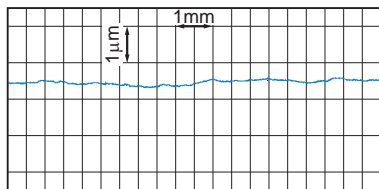

After travel

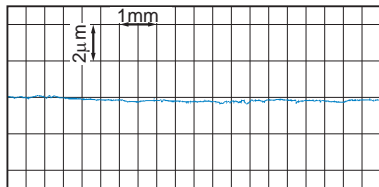

#### General-purpose bearing grease

Before travel

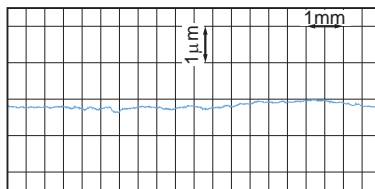

After travel

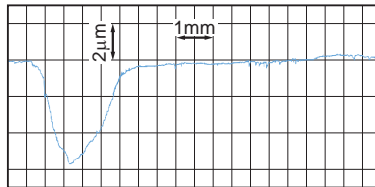

## THK Original Grease

# AFE-CA Grease

- Base oil: high-grade synthetic oil
- Consistency enhancer: urea-based



AFE-CA Grease uses urea as a consistency enhancer and a high-grade synthetic oil as the base oil. It has low dust generative characteristics and is therefore a suitable grease for clean room environments.

### [Features]

#### (1) Low dust generation

Compared with vacuum greases in conventional use, AFE-CA Grease generates less dust and therefore is ideal for use in clean rooms.

#### (2) Long service life

Unlike ordinary soap based grease for metal lubrication, AFE-CA Grease excels in anti-oxidation stability and therefore can be used for a long period of time. As a result, maintenance work is reduced.

### [Representative Physical Properties]

Item	Representative value	Test method
Consistency enhancer	Urea-based	
Base oil	high-grade synthetic oil	
Base oil kinematic viscosity: mm <sup>2</sup> /s (40°C)	99	JIS K 2220 23
Worked penetration (25°C, 60W)	280	JIS K 2220 7
Mixing stability (100,000 W)	310	JIS K 2220 15
Dropping point °C	260	JIS K 2220 8
Evaporation amount: mass% (99°C, 22h)	0.1	JIS K 2220 10
Oil separation rate: mass% (100°C, 24h)	0.1	JIS K 2220 11
Copper plate corrosion (B method, 100°C, 24h)	Accepted	JIS K 2220 9
Low temperature torque: N·m (-20°C)	Start	130
	(revolutions)	76
4-ball testing (burn-in load): N	1236	ASTM D2596
Service Temperature Range °C	-40 to 180	
Color	Light yellowish brown	

### [Test Data on Low Dust Generative Characteristics]

#### ● Test Data on AFE-CA Grease (Comparison of Particle Accumulation)

The test data in the figure compares the results of particle accumulation testing on this product and other greases.

<Test conditions>

Item	Description
Sample model No.	THK KR4610
Screw Ball rotational speed	1000min <sup>-1</sup>
Stroke	210mm
Grease quantity	2 cc in both the Ball Screw and the LM Guide
Flow rate during measurement	1ℓ/min
Measuring instrument	Dust counter
Particle size	0.5μm

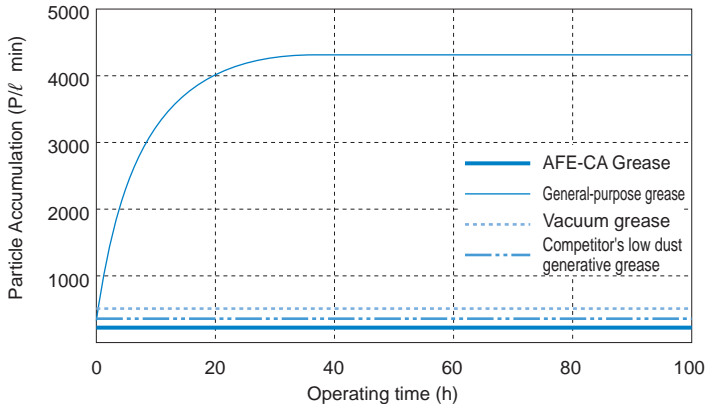

## THK Original Grease

# AFF Grease

- Base oil: high-grade synthetic oil
- Consistency enhancer: lithium-based



AFF Grease uses a high-grade synthetic oil, lithium-based consistency enhancer and a special additive. It achieves stable rolling resistance, low dust generation and high fretting resistance, at a level that conventional vacuum greases or low dust generation greases have not reached.

### [Features]

- (1) Stable rolling resistance  
Since the viscous resistance is low, the rolling resistance fluctuation is also low. Thus, superb conformity is achieved at low speed.
- (2) Low dust generation  
AFF Grease generates little dust, making itself an ideal grease for use in clean rooms.
- (3) Fretting resistance  
Since AFF Grease is more resistant to wear from microvibrations than other low particle generative grease, it allows the greasing interval to be extended.

### [Representative Physical Properties]

Item	Representative value	Test method
Consistency enhancer	Lithium-based	
Base oil	high-grade synthetic oil	
Base oil kinematic viscosity: mm <sup>2</sup> /s (40°C)	100	JIS K 2220 23
Worked penetration (25°C, 60W)	315	JIS K 2220 7
Mixing stability (100,000 W)	345	JIS K 2220 15
Dropping point °C	220	JIS K 2220 8
Evaporation amount: mass% (99°C, 22h)	0.7	JIS K 2220 10
Oil separation rate: mass% (100°C, 24h)	2.6	JIS K 2220 11
Copper plate corrosion (B method, 100°C, 24h)	Accepted	JIS K 2220 9
Low temperature torque: N-m (-20°C)	Start	220
	(revolutions)	60
4-ball testing (burn-in load): N	1236	ASTM D2596
Service Temperature Range °C	-40 to 120	
Color	Reddish brown	

## [Grease viscosity resistance measurements]

&lt;Test conditions&gt;

Item	Description
Model No.	HSR25A1C1+580LP
Grease quantity	3cm <sup>3</sup> / LM block (initial lubrication only)
Feeding speed	10mm/s

• Grease viscosity resistance (Temperature: 23°C)

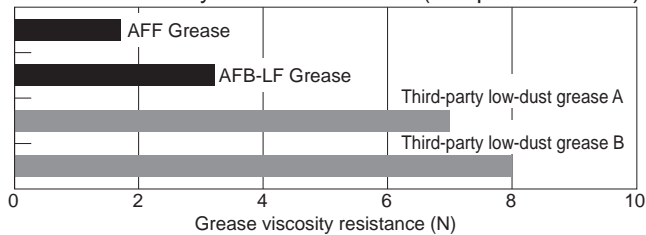

### [Test Data on Low Dust Generative Characteristics]

#### ● Test Data on AFF Grease (Comparison of Particle Accumulation)

The test data in the figure compares the results of particle accumulation testing on this product and other greases.

<Test conditions>

Item	Description
Model No.	SR20W1+280LP
Grease quantity	1 cm <sup>3</sup> / LM block (initial lubrication only)
Amount of air supplied	500cm <sup>3</sup> /min
[Measurement instrument]	Particle counter
Diameter of particle measured	0.3μm or more
Feeding speed	30m/min
Stroke	200mm

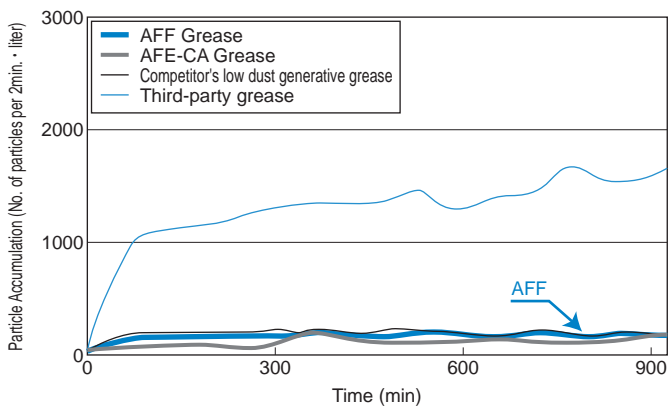



### [Rolling Resistance Characteristics at Low Speed]

#### ● Rolling Resistance at Low Speed

The data in the figure represent the test results of comparing rolling resistances at low speed between AFF Grease and other greases.

<Test conditions>

Item	Description
Model No.	HSR35RC0+440LP
Grease quantity	4cm <sup>3</sup> / LM block (initial lubrication only)
Feeding speed	1mm/s
Stroke	3mm

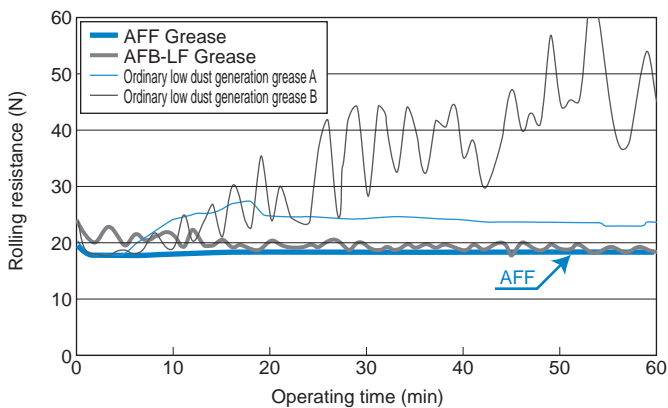

## THK Original Grease

# AFG Grease

- Base oil: high-grade synthetic oil
- Consistency enhancer: urea-based



AFG Grease is a high-grade grease for Ball Screws that uses a high-grade synthetic oil as the base oil and a urea-based consistency enhancer. It excels in low heat generation and supports a wide temperature range from low to high temperature.

### [Features]

- (1) Low heat generation  
Since the viscous resistance is low, the grease generates only a minimal level of heat even during high-speed operation.
- (2) Low viscosity  
Since the viscosity is low, a stable rotational torque is achieved.
- (3) Wide temperature range  
Maintains a high level of lubricity in a wide temperature range of  $-45^{\circ}\text{C}$  to  $+160^{\circ}\text{C}$ .
- (4) Long service life  
AFG Grease is not easily softened and excels in antioxidation stability even after a long-term operation.
- (5) Water resistance  
AFG Grease is a highly water resistant grease that is less vulnerable to moisture penetration and little decreases resistance to extreme pressure.

### [Representative Physical Properties]

Item	Representative value	Test method
Consistency enhancer	Urea-based	
Base oil	high-grade synthetic oil	
Base oil kinematic viscosity: $\text{mm}^2/\text{s}$ ( $40^{\circ}\text{C}$ )	25	JIS K 2220 23
Worked penetration ( $25^{\circ}\text{C}$ , 60W)	285	JIS K 2220 7
Mixing stability (100,000 W)	329	JIS K 2220 15
Dropping point $^{\circ}\text{C}$	261	JIS K 2220 8
Evaporation amount: mass% ( $99^{\circ}\text{C}$ , 22h)	0.2	JIS K 2220 10
Oil separation rate: mass% ( $100^{\circ}\text{C}$ , 24h)	0.5	JIS K 2220 11
Copper plate corrosion (B method, $100^{\circ}\text{C}$ , 24h)	Accepted	JIS K 2220 9
Low temperature torque: N·m ( $-20^{\circ}\text{C}$ )	Start	JIS K 2220 18
	(revolutions)	
4-ball testing (burn-in load): N	3089	ASTM D2596
Service Temperature Range $^{\circ}\text{C}$	$-45$ to $160$	
Color	Brown	

### [Test Data on Low Heat Generation Characteristics]

#### ● Test Data on AFG Grease (Comparison of Heat Generation)

The test data in the figure represent the results of comparing heat generation between AFG Grease and other greases.

<Test conditions>

Item	Description
Shaft diameter/lead	32/10mm
Feeding speed	67 to 500mm/s
Shaft rotation speed	400 to 3000 min <sup>-1</sup>
Stroke	400mm
Grease quantity	12cm <sup>3</sup>
Temperature measurement point	Nut circumference

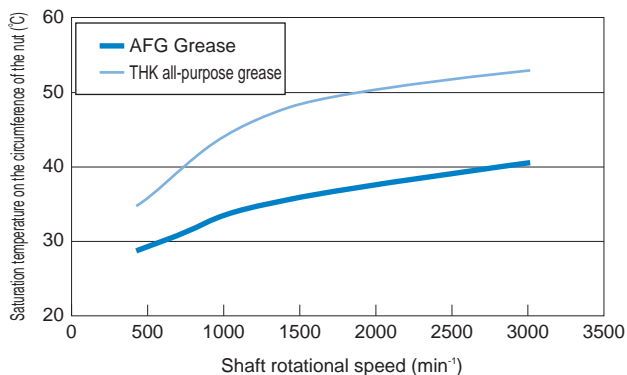

## THK Original Grease

# AFJ Grease

- Base oil: refined mineral oil
- Consistency enhancer: urea-based



The THK AFJ grease uses refined mineral oil as its base and contains urea-based consistency enhancer and other special additives that give excellent lubrication properties at a wide range of speeds, from low to high.

### [Features]

- (1) Wide range of speeds  
Provides consistent and even lubrication at both high and low work speeds.
- (2) Wear Resistance  
Even at low speeds, it has excellent oil film formation characteristics to reduce wear.
- (3) Resistant to vibration  
Reduces wear caused by machine vibration during high-speed operation.
- (4) Low rolling resistance  
Reduces rolling resistance in LM guides and ball screws over a wide range of speeds.

### [Representative Physical Properties]

Item	Representative value	Test method
Consistency enhancer	Urea-based	
Base oil	refined mineral oil	
Base oil kinematic viscosity: mm <sup>2</sup> /s (40°C)	20	JIS K 2220 23
Worked penetration (25°C, 60W)	325	JIS K 2220 7
Mixing stability (100,000 W)	360	JIS K 2220 15
Dropping point °C	185	JIS K 2220 8
Evaporation amount: mass% (99°C, 22h)	0.6	JIS K 2220 10
Oil separation rate: mass% (100°C, 24h)	7.0	JIS K 2220 11
Copper plate corrosion (B method, 100°C, 24h)	Accepted	JIS K 2220 9
Low temperature torque: N·m (-20°C)	Start	380
	(revolutions)	130
4-ball testing (burn-in load): N	3089	ASTM D2596
Service Temperature Range °C	-20 to 120	
Color	Yellowish brown	

### [Test data for LM guide block wear resistance]

#### ● AFJ grease test data (comparing the amount of wear)

The test data in the figure compares the test results for the amount of wear for this product and other greases.

<Test conditions>

Item	Description
Model No.	NRS55B2SS+780LP
Applied load	5.9kN
Feeding speed	0.1m/min
Stroke	200mm
Grease quantity	12cm/ LM block (initial lubrication only)
Test duration	480 hours

#### THK AFJ Grease

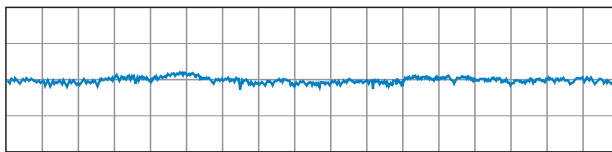

#### Other urea-based grease

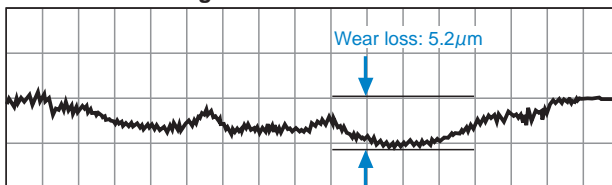

### [Test data for LM guide rail vibration resistance]

#### ● AFJ grease test data (comparing the amount of vibration)

The test data in the figure compares the test results for the amount of vibration for this product and other greases.

<Test conditions>

Item	Description
Model No.	SHS25R1UU+580LP
Applied load	11.05 kN (0.35C)
Feeding speed	60 m/min
Acceleration/deceleration	9.8 m/s <sup>2</sup>
Stroke	350mm
Grease quantity	2 cm <sup>3</sup> /block

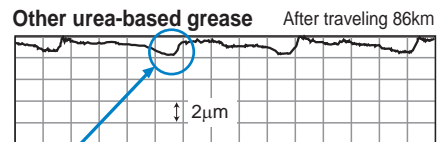
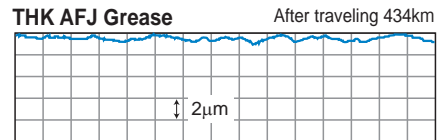

### "Wear Occurrence Mechanisms"

Patterns of high-speed and high acceleration/deceleration operation

Occurrence of machine vibration

Occurrence of wear in roll grooves

### [Measurement data for LM guide rolling resistance]

#### ● AFJ grease test data (rolling resistance comparison)

The test data in the figure compares the results of rolling resistance testing on this product and other greases.

<Test conditions>

Item	Description
Model No.	SHS25R1UU+3000L
Applied load	No load
Acceleration	29.4 m/s <sup>2</sup> (3G)
Stroke	2300mm
Test temperature	21 °C
Grease quantity	2 cm <sup>3</sup> /block
Measurement speed	0.5, 1, 2, 3, 4, 5, 6 m/s

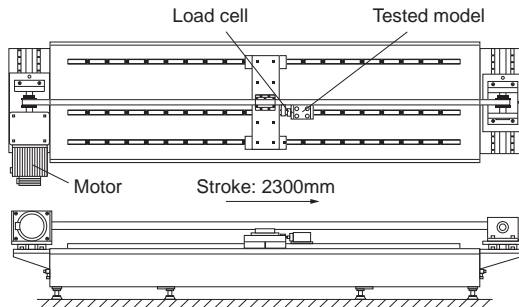
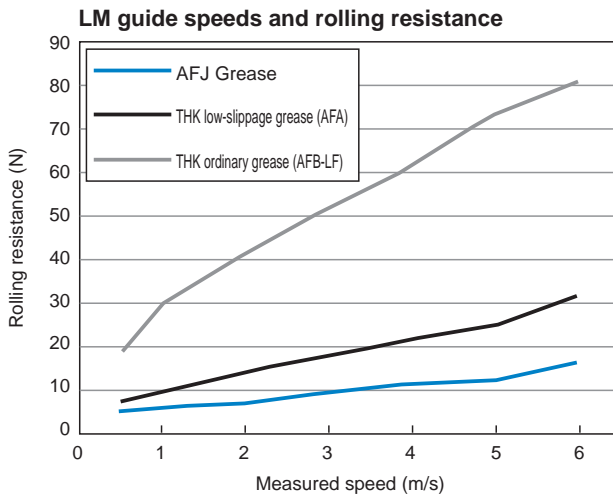

## Lubrication Equipment

## Grease Gun Unit MG70

- Discharge pressure: 19.6 MPa max
- Discharge rate: 0.6 cc/stroke
- Grease: 70 g bellows cartridge
- Overall length: 235 mm (excluding the nozzle)
- Weight: 480 g (including the nozzle, excluding the grease)



Grease Gun Unit MG70 is capable of lubricating small to large types of LM Guides by replacing dedicated nozzles (attached). For small LM Guides, MG70 is provided with dedicated attachments. The user can select from these attachments according to the model number and the installation space. MG70 has a slit window, allowing the user to check the remaining amount of grease.

It is equipped with a bellows cartridge that can hold 70 g of grease and is replaceable without smirching your hand. It supports a wide range of grease products, including AFA Grease, AFB-LF Grease, AFC Grease and AFE-CA Grease, to meet varied conditions. This enables you to make a selection according to the area requiring grease. (See **A24-7** to **A24-23**.)

Grease not included with the MG70 Grease Gun Unit. Grease sold separately.

Table for Supported Model Numbers

Type	Dimensions	Supported model numbers	
Type N		LM Guide	Models SSR15, SHS15, SR15, HSR12, HSR15, CSR15, HRW17, GSR15, RSR15, HCR12 and HCR15
		Cam Follower	Models CF, CFN and CFH
		Rod End	Models PHS5 to 22 and POS8 to 22
Type P		LM Guide	Models HSR8, HSR10, HRW12, HRW14 and RSR12
		Cam Follower	Model CF-AB
Type L		LM Guide	Models HSR8, HSR10, HRW12, HRW14 and RSR12
Type H		LM Guide	Models with grease nipple M6F or PT1/8
		Ball screw	
		Rod End	Models PHS25, PHS30, POS25 and POS30
Dedicated nozzle type U		—	—

Note) Types P and L are also capable of greasing less accessible areas other than the model numbers above (by dropping grease on the raceway).

## Model number coding

## MG70

(THK offers grease guns only for a 70g cartridge.)

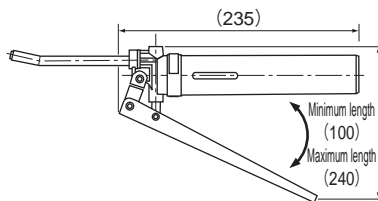



## Accessories for Lubrication

## Special Plumbing Fixtures

For centralized greasing and oil lubrication, special plumbing fixtures are available from THK. When ordering an LM system, specify the model number, mounting orientation and piping direction. We will ship the LM system attached with the corresponding fixture.

LF-A  
LF-B  
LF-E

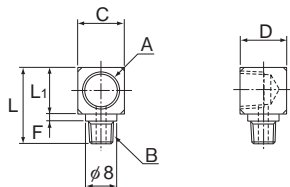

Unit: mm

Model	A Screw (female thread)	B Screw (male thread)	L	L <sub>1</sub>	F	C	D
LF-A	PT1/8	M6×0.75	20	12	2	12	12
LF-B	M8×1	M6×0.75	18.5	10	2.5	9.5	18
LF-E	PT1/8	M6×1	20	12	2	12	12

LF-C  
LF-D

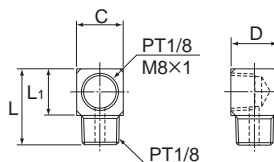

Unit: mm

Model	Screw	L	L <sub>1</sub>	C	D
LF-C	PT1/8	20	12	12	12
LF-D	M8×1	18	10	10	18

SF-A  
SF-B  
SF-E

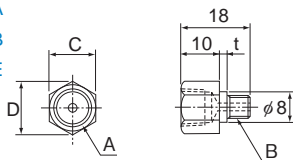

Unit: mm

Model	A Screw (female thread)	B Screw (male thread)	t	C	D
SF-A	PT1/8	M6×0.75	2	12	13.8
SF-B	M8×1	M6×0.75	2	10	11.5
SF-E	PT1/8	M6×1	2	12	13.8

SF-C  
SF-D

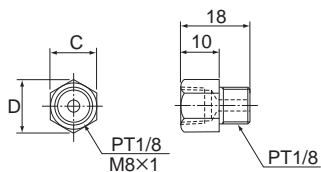

Unit: mm

Model	Screw	C	D
SF-C	PT1/8	12	13.8
SF-D	M8×1	10	11.5

LD

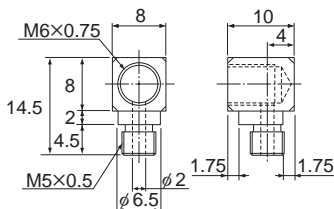

Unit: mm

Model	Screw
LD	M6×0.75

## Accessories for Lubrication

## Grease Nipple

THK provides various types of grease nipples needed for the lubrication of LM systems.

A-MT6×1 (MT6×1)

A-M6F (M6×0.75)

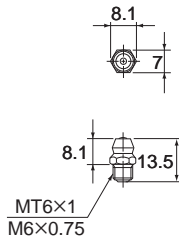

B-MT6×1 (MT6×1)

B-M6F (M6×0.75)

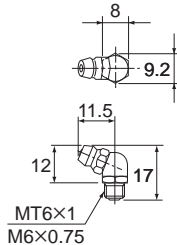

C-MT6×1 (MT6×1)

C-M6F (M6×0.75)

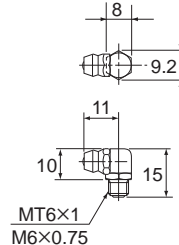

A-PT1/8

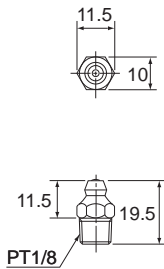

B-PT1/8

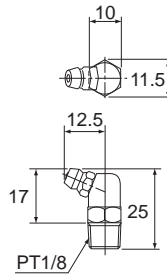

C-PT1/8

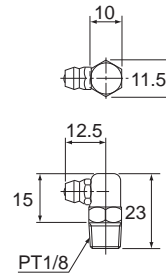

PB107

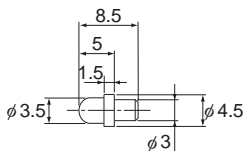

NP3.2×3.5

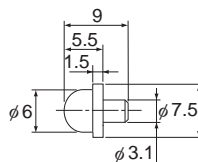

PB1021B

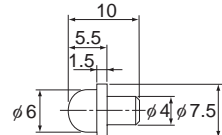

NP6×5

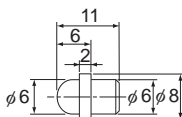

NP8×9

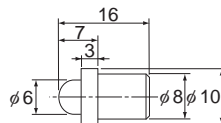

---

## Model Number Coding

---

Model number configurations differ depending on the model features. Refer to the corresponding sample model number configuration.

### [Grease Gun]

#### ● Model MG70

---

## MG70

(THK offers grease guns only for a 70g cartridge.)

---

### [THK Original Grease]

#### ● Models AFA, AFB-LF, AFC, AFE-CA, AFF, AFG and AFJ

---

●Type of packing···bellows cartridge

**AFC + 70**

Cartridge capacity (70 g / 400 g)

Type of grease (AFA Grease, AFB-LF Grease, AFC Grease, AFE-CA Grease, AFF Grease, AFG Grease, AFJ Grease)

---





# Accessories for Lubrication

THK General Catalog

## B Support Book

<b>Lubrication</b> .....	A24-2
Types of Lubricants .....	A24-2
• Grease Lubrication .....	A24-3
• Oil Lubrication .....	A24-3
Lubrication under Special Environments ..	A24-4
Lubrication Methods .....	A24-5
• Manual Lubrication .....	A24-5
• Forced Lubrication Method .....	A24-5
Lubrication Accessory Series for LM Systems ..	A24-6
• THK Original Grease .....	A24-6
AFA Grease .....	A24-7
AFB-LF Grease .....	A24-8
AFC Grease .....	A24-10
AFE-CA Grease .....	A24-12
AFF Grease .....	A24-14
AFG Grease .....	A24-18
AFJ Grease .....	A24-20
Grease Gun Unit MG70 .....	A24-24
Special Plumbing Fixtures .....	A24-24
Grease Nipple .....	A24-24
<b>Model No.</b> .....	A24-25
• Model Number Coding .....	A24-25

## A Product Descriptions (Separate)

<b>Lubrication</b> .....	A24-2
Types of Lubricants .....	A24-2
• Grease Lubrication .....	A24-3
• Oil Lubrication .....	A24-3
Lubrication under Special Environments ..	A24-4
Lubrication Methods .....	A24-5
• Manual Lubrication .....	A24-5
• Forced Lubrication Method .....	A24-5
Lubrication Accessory Series for LM Systems ..	A24-6
• THK Original Grease .....	A24-6
AFA Grease .....	A24-7
AFB-LF Grease .....	A24-8
AFC Grease .....	A24-10
AFE-CA Grease .....	A24-12
AFF Grease .....	A24-14
AFG Grease .....	A24-18
AFJ Grease .....	A24-20
Grease Gun Unit MG70 .....	A24-24
Special Plumbing Fixtures .....	A24-25
Grease Nipple .....	A24-26
<b>Model No.</b> .....	A24-27
• Model Number Coding .....	A24-27

When using an LM system, it is necessary to provide effective lubrication. Without lubrication, the rolling elements or the raceway may be worn faster and the service life may be shortened.

A lubricant has effects such as the following.

- (1) Minimizes friction in moving elements to prevent seizure and reduce wear.
- (2) Forms an oil film on the raceway to decrease stress acting on the surface and extend rolling fatigue life.
- (3) Covers the metal surface to prevent rust formation.

To fully bring out an LM system's functions, it is necessary to provide lubrication according to the conditions.

It is necessary to consider the mounting positions of the grease nipple and piping joint according to the installation direction.

(If the installation direction of the LM Guide is other than horizontal installation, the lubricant may not reach the raceway completely. Be sure to let THK know the mounting orientation and the exact position in each LM block where the grease nipple or the piping joint should be attached. For the mounting position of the LM Guide, see [B1-28](#).)

Even with an LM system with seals, the internal lubricant gradually seeps out during operation. Therefore, the system needs to be lubricated at an appropriate interval according to the conditions.

## Types of Lubricants

LM systems mainly use grease or sliding surface oil for their lubricants.

The requirements that lubricants need to satisfy generally consist of the following.

- (1) High oil film strength
- (2) Low friction
- (3) High wear resistance
- (4) High thermal stability
- (5) Non-corrosive
- (6) Highly anti-corrosive
- (7) Minimal dust/water content
- (8) Consistency of grease must not be altered to a significant extent even after it is repeatedly stirred.

For lubricants that meet these requirements, see [B24-3](#).

## Grease Lubrication

Greasing intervals vary depending on the conditions and environments. For normal use, we recommend greasing the system approximately every 100 km of travel distance.

Normally, replenish grease of the same group from the grease nipple or greasing hole provided on the LM system. Mixing different types of grease may deteriorate the system's performance, such as increased consistency.

Lubricant	Type	Brand name
Grease	Lithium-based grease (JIS No. 2) Urea-based grease (JIS No. 2)	AFA Grease (THK) see <a href="#">B24-7</a> AFB-LF Grease (THK) see <a href="#">B24-8</a> AFC Grease (THK) see <a href="#">B24-10</a> AFE-CA Grease (THK) see <a href="#">B24-12</a> AFF Grease (THK) see <a href="#">B24-14</a> AFG Grease (THK) see <a href="#">B24-18</a> AFJ Grease (THK) see <a href="#">B24-20</a>  Alvania Grease S No.2(Showa Shell Sekiyu) Eponex Grease No.2(Idemitsu) or equivalent

\*Recommended greases vary according to the conditions and environment. See [B24-6](#) to [B24-23](#) for details.

## Oil Lubrication

LM systems that require oil lubrication are shipped with only anti-rust oil applied. When placing an order, specify the required lubricant oil.

(If the installation direction of the LM Guide is other than horizontal installation, the lubricant may not reach the raceway completely. Be sure to let THK know the mounting orientation of the LM Guide.

For the mounting position of the LM Guide, see [B1-28](#).)

- The amount of oil to be supplied varies with stroke length. For a long stroke, increase the lubrication frequency or the amount of oil so that an oil film reaches the stroke end of the raceway.
- In environments where a liquid coolant is splattered, the lubricant will be mixed with the coolant, and this can result in the lubricant being emulsified or washed away, causing significantly degraded lubrication performance. In such settings, apply a lubricant with high viscosity (kinematic viscosity: approx. 68 cst) and high emulsification-resistant, and adjust the lubrication frequency or the amount of the feed lubricant.

For machine tools and similar devices that are subject to heavy loads and require high rigidity and operate at high speed, it is advisable to apply oil lubrication.

- Make sure that lubrication oil normally discharges from the ends of your lubrication piping, i.e., the oiling ports that connect to your LM system.

Lubricant	Type	Brand name
Oil	Sliding surface oil or turbine oil ISOVG32 to 68	Super Multi 32 to 68 (Idemitsu) Vactra No.2SLC (Exxon Mobil) DTE Oil (Exxon Mobil) Tonna Oil S (Showa Shell Sekiyu) or equivalent

## Lubrication under Special Environments

For use under special conditions, such as continual vibrations, clean room, vacuum, low temperature and high temperature, normal grease may not be used in some cases. For lubricants that meet such conditions, contact THK.

Table1 Lubricants Used under Special Environments

Service environment	Lubricant characteristics	Brand name
High-speed moving parts	Grease with low torque and low heat generation	AFG Grease (THK) see <a href="#">B24-18</a> AFA Grease (THK) see <a href="#">B24-7</a> AFJ Grease (THK) see <a href="#">B24-20</a> NBU15(NOK Kluba) Multemp (Kyodo Yushi) or equivalent
Vacuum	Fluorine based vacuum grease or oil (vapor pressure varies by brand) <small>Note 1</small>	Fomblin Y-VAC2/3 (Solvay) Demnum L-65/200 (Daikin Industries, Ltd) Barrierta IEL/V (NOK Kluba) Logenest lambda (Nippon Koyu)
Clean room	Grease with very low dust generation	AFE-CA Grease (THK) see <a href="#">B24-12</a> AFF Grease (THK) see <a href="#">B24-14</a>
Environments subject to microvibrations or microstrokes, which may cause fretting corrosion	Grease that easily forms an oil film and has high fretting resistance	AFC Grease (THK) see <a href="#">B24-10</a>
Environments subject to a spattering coolant such as machine tools	Highly anti-corrosive, refined mineral oil or synthetic oil that forms a strong oil film and is not easily emulsified or washed away by coolant Water-resistant grease <small>Note 2</small>	Super Multi 68 (Idemitsu) Vactra No.2SLC (Exxon Mobil) or equivalent

Note1) When using a vacuum grease, be sure that some brands have starting resistances several times greater than ordinary lithium-based greases.

Note2) In an environment subject to a spattering water-soluble coolant, some brands of intermediate viscosity significantly decrease their lubricity or do not properly form an oil film. Check the compatibility between the lubricant and the coolant.

Note3) Do not mix greases with different physical properties.



## Lubrication Methods

There are roughly three methods of lubricating LM systems: manual lubrication using a grease gun or manual pump; forced oiling with the aid of an automatic pump; and oil-bath lubrication.

To achieve efficient lubrication, it is necessary to mount the grease nipple or the piping joint according to the installation direction.

(If the installation direction of the LM Guide is other than horizontal installation, the lubricant may not reach the raceway completely. Be sure to let THK know the mounting orientation and the exact position in each LM block where the grease nipple or the piping joint should be attached. For the mounting position of the LM Guide, see [B1-28](#).)

### Manual Lubrication

Generally, grease is replenished periodically, fed through a grease nipple provided on the LM system, using a grease gun. (Fig.1)

For systems that have many locations to be lubricated, establish a centralized piping system and periodically provide grease from a single point using a manual pump. (Fig.2)

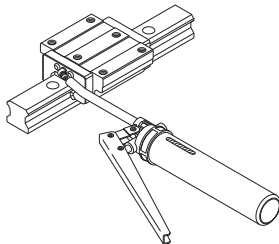

Fig.1 Lubrication Using a Grease Gun

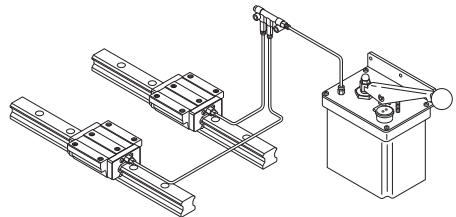

Fig.2 Lubrication through a Centralized Piping System

Note) When a centralized piping system is used, lubricant may not reach the pipe end due to the viscous resistance inside the pipe. Select the right type of grease while taking into account the consistency of the grease and the pipe diameter.

### Forced Lubrication Method

In this method, a given amount of lubricant is forcibly fed at a given interval. Normally, the lubricant is not collected after use. (Fig.3)

Although a special lubrication system using a piping or the like needs to be designed, this method reduces the likelihood of forgetting to replenish lubricant.

This method is used mainly for oil lubrication. If using grease, it is necessary to examine the appropriate piping diameter and the required grease consistency.

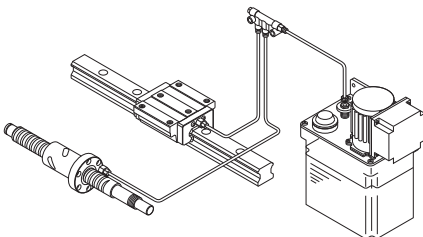

Fig.3 Forced Lubrication Method

# Lubrication Accessory Series for LM Systems

THK provides a wide array of lubrication accessories such as grease, grease guns, grease nipples and plumbing fixtures available for various applications. (B24-7 to B24-24)

## THK Original Grease

THK provides various types of THK original greases needed for the lubrication of LM systems. They are available for various conditions and environments.

### [Table for Grease Selection]

Refer to the table below that allows you to select a type of grease according to the application of the LM system. Also note that the color of the decorative package varies according to the type (both 70 g and 400 g).

Name of grease	AFA Grease	AFB-LF Grease	AFC Grease	AFC-CA Grease	AFF Grease	AFG Grease	AFJ Grease
Features	Low-Resistance grease	All-purpose grease	High-speed/micro-vibration grease	Grease for clean environment	Grease for clean environment	Grease for heat of Ball Screw	Grease suited to a wide range of speeds
Base oil	high-grade synthetic oil	refined mineral oil	high-grade synthetic oil	high-grade synthetic oil	high-grade synthetic oil	high-grade synthetic oil	refined mineral oil
Consistency enhancer	Urea-based	Lithium-based	Urea-based	Urea-based	Lithium-based	Urea-based	Urea-based
Industrial machinery	General industrial machinery	—	◎	—	—	—	—
	High Speed	◎	—	—	—	◎	○
	High Load	—	◎	—	—	—	—
Machine tool	General machine tools	—	◎	—	—	—	—
	High Speed	○	—	—	—	◎	○
	High acceleration/deceleration	—	—	—	—	—	◎
	Micro-vibration	—	—	◎	—	—	—
Semiconductor manufacturing equipment	General semiconductor fabrication equipment	—	◎	—	—	—	—
	High Speed	◎	—	—	—	○	○
	Micro-vibration	—	—	◎	—	○	—
	High acceleration/deceleration	—	—	—	—	—	◎
	Clean environments	—	—	—	◎	◎	—
Special environments	Low-resistance	◎	—	—	—	○	○
	Low heat generation	—	—	—	—	◎	—
	Wide range of speeds	—	—	—	—	—	◎
	Wide temperature range	—	—	◎	—	—	—
Color of decorative package	Green	Orange	Mazarine	Lime green	Light blue	Blue	Yellow
Reference page	B24-7	B24-8	B24-10	B24-12	B24-14	B24-18	B24-20

### Model number coding

•Type of packing···bellows cartridge

**AFC + 70**

Cartridge capacity (70 g / 400 g)

Type of grease (AFA Grease, AFB-LF Grease, AFC Grease, AFC-CA Grease, AFF Grease, AFG Grease, AFJ Grease)

## THK Original Grease

# AFA Grease

- Base oil: high-grade synthetic oil
- Consistency enhancer: urea-based



AFA Grease is a high-grade, long-life grease developed with a urea-based consistency enhancer using a high-grade synthetic oil as the base oil.

### [Features]

- Long service life**  
Unlike ordinary soap based grease for metal lubrication, AFA Grease excels in antioxidant stability and therefore can be used for a long period of time.
- Wide temperature range**  
The lubricating performance remains high over a wide range of temperatures from -45°C to +160°C.  
Even at low temperatures, AFA Grease requires only a low starting torque.
- High water resistance**  
AFA Grease is less vulnerable to moisture penetration than other types of grease because of its high water resistance.
- High mechanical stability**  
AFA Grease is not easily softened and demonstrates excellent mechanical stability even when used for a long period of time.

### [Representative Physical Properties]

Item	Representative value	Test method
Consistency enhancer	Urea-based	
Base oil	high-grade synthetic oil	
Base oil kinematic viscosity: mm <sup>2</sup> /s (40°C)	25	JIS K 2220 23
Worked penetration (25°C, 60W)	285	JIS K 2220 7
Mixing stability (100,000 W)	329	JIS K 2220 15
Dropping point °C	261	JIS K 2220 8
Evaporation amount: mass% (99°C, 22h)	0.2	JIS K 2220 10
Oil separation rate: mass% (100°C, 24h)	0.5	JIS K 2220 11
Copper plate corrosion (B method, 100°C, 24h)	Accepted	JIS K 2220 9
Low temperature torque: N·m (-20°C)	Start	170
	(revolutions)	70
4-ball testing (burn-in load): N	3089	ASTM D2596
Service Temperature Range °C	-45 to 160	
Color	Brown	

### [Rotation Torque Testing with Ball Screw Grease]

<Test method>

Apply 1 cc of grease to the LM Guide of KR4620A+640L and 2 cc to the Ball Screw (initial lubrication only), and then measure the torque at each motor rotation speed.

In torque measurement, output values on the driver torque monitor are used.

Comparative Table of Rotation Torque of Ball Screws by Grease

Unit: N·cm

Grease	Central value of dynamic viscosity CST (mm <sup>2</sup> /s)(40°C)	Dynamic viscosity range CST (mm <sup>2</sup> /s)(40°C)	Rotational speed			
			100min <sup>-1</sup>	1000min <sup>-1</sup>	2000min <sup>-1</sup>	4000min <sup>-1</sup>
AFA Grease	25	22.5 to 27.5	11.27	11.27	12.25	14.6
Grease of manufacturer I	130	117 to 143	14.6	23.13	31.16	43.12
Grease of manufacturer K	15.3	13.8 to 16.8	12.64	12.05	13.03	14.41
Lubricant VG32	32	28.8 to 35.2	11.17	10.78	13.43	14.7

Note) The values of the competitors' greases are that of low-torque greases.

## THK Original Grease

# AFB-LF Grease

- Base oil: refined mineral oil
- Consistency enhancer: lithium-based



AFB-LF Grease is a general-purpose grease developed with a lithium-based consistency enhancer using refined mineral oil as the base oil. It excels in extreme pressure resistance and mechanical stability.

### [Features]

- (1) High extreme pressure resistance  
Compared with lithium-based greases available on the market, AFB-LF Grease has higher wear resistance and outstanding resistance to extreme pressure.
- (2) High mechanical stability  
AFB-LF Grease is not easily softened and demonstrates excellent mechanical stability even when used for a long period of time.
- (3) High water resistance  
Compared with ordinary lithium grease, this product is a highly water resistant grease with minimal softening due to moisture penetration and very little deterioration under extreme pressures.
- (4) Long service life  
It provides many times the lubrication life of lithium soap-based greases. As a result, it offers a lower maintenance workload and greater economy due to the longer intervals between greasing.

### [Representative Physical Properties]

Item	Representative value	Test method
Consistency enhancer	Lithium-based	
Base oil	refined mineral oil	
Base oil kinematic viscosity: mm <sup>2</sup> /s (40°C)	170	JIS K 2220 23
Worked penetration (25°C, 60W)	275	JIS K 2220 7
Mixing stability (100,000 W)	345	JIS K 2220 15
Dropping point °C	193	JIS K 2220 8
Evaporation amount: mass% (99°C, 22h)	0.4	JIS K 2220 10
Oil separation rate: mass% (100°C, 24h)	0.6	JIS K 2220 11
Copper plate corrosion (B method, 100°C, 24h)	Accepted	JIS K 2220 9
Low temperature torque: N·m (-20°C)	Start	130
	(revolutions)	51
4-ball testing (burn-in load): N	3089	ASTM D2596
Service Temperature Range °C	-15 to 100	
Color	Yellowish brown	

**[Comparison of Grease Service Life Data]**

<Test products>

LM Guide HSR25CA1SS + 600L

<Test conditions>

Load : 9.8 kN/block

Stroke : 350mm

Speed : 30m/min (MAX)

Time constant : 200msec

Greasing quantity : 4g/block (initial lubrication only)

Travel distance until flaking occurs by grease type

Grease	Distance	(km)							
		0	100	200	300	400	500	600	700
AFB-LF Grease									
Ordinary lithium-soap based grease									

## THK Original Grease

# AFC Grease

- Base oil: high-grade synthetic oil
- Consistency enhancer: urea-based



AFC Grease has high fretting-corrosion resistance due to a special additive and a urea-based consistency enhancer using a high-grade synthetic oil as the base oil.

### [Features]

- (1) High fretting-corrosion resistance  
AFC Grease is designed to be highly effective in preventing fretting corrosion.
- (2) Long service life  
Unlike ordinary soap based grease for metal lubrication, AFC Grease excels in antioxidant stability and therefore can be used for a long period of time. As a result, maintenance work is reduced.
- (3) Wide temperature range  
Since a high-grade synthetic oil is used as the base oil, the lubricating performance remains high over a wide range of temperatures from -54 °C to +177 °C.

### [Representative Physical Properties]

Item	Representative value	Test method
Consistency enhancer	Urea-based	
Base oil	high-grade synthetic oil	
Base oil kinematic viscosity: mm <sup>2</sup> /s (40°C)	25	JIS K 2220 23
Worked penetration (25°C, 60W)	288	JIS K 2220 7
Mixing stability (100,000 W)	341	JIS K 2220 15
Dropping point °C	269	JIS K 2220 8
Evaporation amount: mass% (99°C, 22h)	0.2	JIS K 2220 10
Oil separation rate: mass% (100°C, 24h)	0.6	JIS K 2220 11
Copper plate corrosion (B method, 100°C, 24h)	Accepted	JIS K 2220 9
Low temperature torque: N·m (-20°C)	Start	JIS K 2220 18
	(revolutions)	
4-ball testing (burn-in load): N	3089	ASTM D2596
Service Temperature Range °C	-54 to 177	
Color	Brown	

### [Test Data on Fretting-corrosion Resistance]

#### ● Test Data on AFC Grease (Comparison of Raceway Conditions)

The test data in the figure shows the results of comparing this product with an ordinary bearing grease.

<Test conditions>

Item	Description
Stroke	3mm
Number of strokes per minute	200min <sup>-1</sup>
Total number of strokes	2.88 × 10 <sup>5</sup> (24 hours)
Surface pressure	1118MPa
Grease quantity	12g/1LM block (replenished every 8 hours)

#### AFC Grease

Before travel

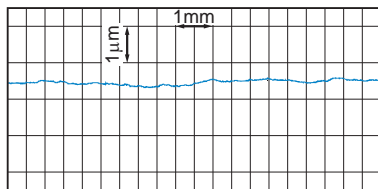

After travel

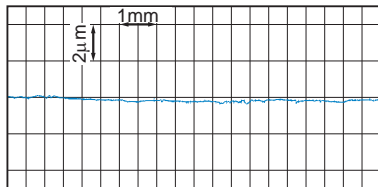

#### General-purpose bearing grease

Before travel

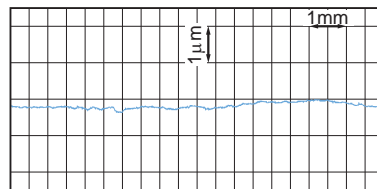

After travel

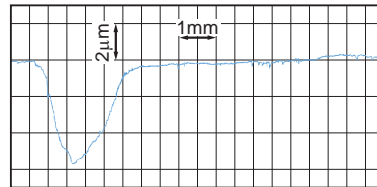

## THK Original Grease

# AFE-CA Grease

- Base oil: high-grade synthetic oil
- Consistency enhancer: urea-based



AFE-CA Grease uses urea as a consistency enhancer and a high-grade synthetic oil as the base oil. It has low dust generative characteristics and is therefore a suitable grease for clean room environments.

### [Features]

#### (1) Low dust generation

Compared with vacuum greases in conventional use, AFE-CA Grease generates less dust and therefore is ideal for use in clean rooms.

#### (2) Long service life

Unlike ordinary soap based grease for metal lubrication, AFE-CA Grease excels in anti-oxidation stability and therefore can be used for a long period of time. As a result, maintenance work is reduced.

### [Representative Physical Properties]

Item	Representative value	Test method
Consistency enhancer	Urea-based	
Base oil	high-grade synthetic oil	
Base oil kinematic viscosity: mm <sup>2</sup> /s (40°C)	99	JIS K 2220 23
Worked penetration (25°C, 60W)	280	JIS K 2220 7
Mixing stability (100,000 W)	310	JIS K 2220 15
Dropping point °C	260	JIS K 2220 8
Evaporation amount: mass% (99°C, 22h)	0.1	JIS K 2220 10
Oil separation rate: mass% (100°C, 24h)	0.1	JIS K 2220 11
Copper plate corrosion (B method, 100°C, 24h)	Accepted	JIS K 2220 9
Low temperature torque: N·m (-20°C)	Start	130
	(revolutions)	76
4-ball testing (burn-in load): N	1236	ASTM D2596
Service Temperature Range °C	-40 to 180	
Color	Light yellowish brown	



### [Test Data on Low Dust Generative Characteristics]

#### ● Test Data on AFE-CA Grease (Comparison of Particle Accumulation)

The test data in the figure compares the results of particle accumulation testing on this product and other greases.

<Test conditions>

Item	Description
Sample model No.	THK KR4610
Screw Ball rotational speed	1000min <sup>-1</sup>
Stroke	210mm
Grease quantity	2 cc in both the Ball Screw and the LM Guide
Flow rate during measurement	1ℓ/min
Measuring instrument	Dust counter
Particle size	0.5μm

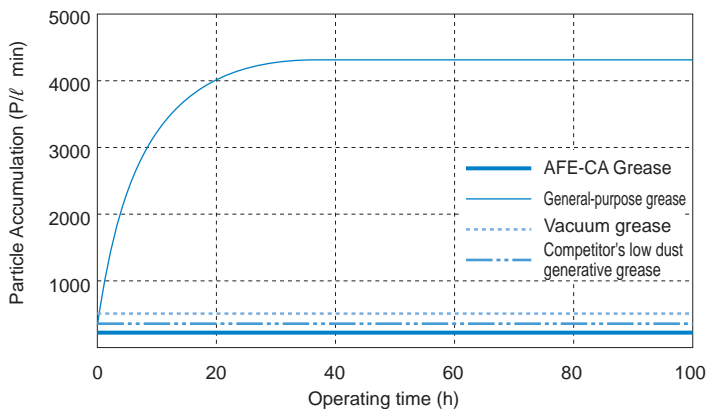

## THK Original Grease

# AFF Grease

- Base oil: high-grade synthetic oil
- Consistency enhancer: lithium-based



AFF Grease uses a high-grade synthetic oil, lithium-based consistency enhancer and a special additive. It achieves stable rolling resistance, low dust generation and high fretting resistance, at a level that conventional vacuum greases or low dust generation greases have not reached.

### [Features]

- (1) Stable rolling resistance  
Since the viscous resistance is low, the rolling resistance fluctuation is also low. Thus, superb conformity is achieved at low speed.
- (2) Low dust generation  
AFF Grease generates little dust, making itself an ideal grease for use in clean rooms.
- (3) Fretting resistance  
Since AFF Grease is more resistant to wear from microvibrations than other low particle generative grease, it allows the greasing interval to be extended.

### [Representative Physical Properties]

Item	Representative value	Test method
Consistency enhancer	Lithium-based	
Base oil	high-grade synthetic oil	
Base oil kinematic viscosity: mm <sup>2</sup> /s (40°C)	100	JIS K 2220 23
Worked penetration (25°C, 60W)	315	JIS K 2220 7
Mixing stability (100,000 W)	345	JIS K 2220 15
Dropping point °C	220	JIS K 2220 8
Evaporation amount: mass% (99°C, 22h)	0.7	JIS K 2220 10
Oil separation rate: mass% (100°C, 24h)	2.6	JIS K 2220 11
Copper plate corrosion (B method, 100°C, 24h)	Accepted	JIS K 2220 9
Low temperature torque: N·m (-20°C)	Start	220
	(revolutions)	60
4-ball testing (burn-in load): N	1236	ASTM D2596
Service Temperature Range °C	-40 to 120	
Color	Reddish brown	

## [Grease viscosity resistance measurements]

&lt;Test conditions&gt;

Item	Description
Model No.	HSR25A1C1+580LP
Grease quantity	3cm <sup>3</sup> / LM block (initial lubrication only)
Feeding speed	10mm/s

• Grease viscosity resistance (Temperature: 23°C)

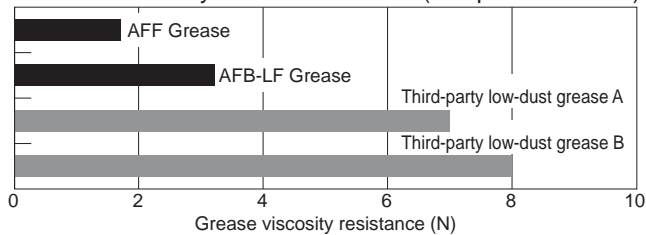

### [Test Data on Low Dust Generative Characteristics]

#### ● Test Data on AFF Grease (Comparison of Particle Accumulation)

The test data in the figure compares the results of particle accumulation testing on this product and other greases.

<Test conditions>

Item	Description
Model No.	SR20W1+280LP
Grease quantity	1 cm <sup>3</sup> / LM block (initial lubrication only)
Amount of air supplied	500cm <sup>3</sup> /min
[Measurement instrument]	Particle counter
Diameter of particle measured	0.3μm or more
Feeding speed	30m/min
Stroke	200mm

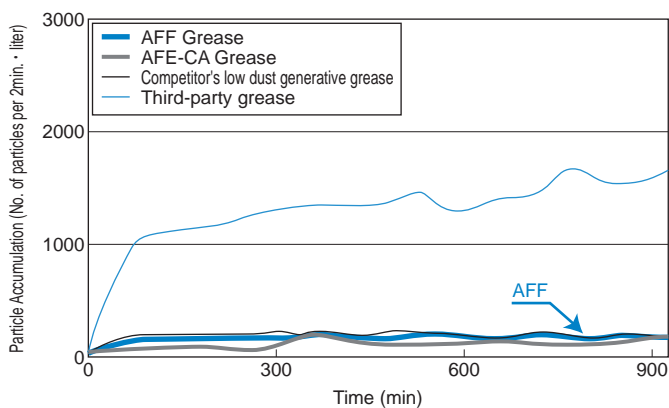

### [Rolling Resistance Characteristics at Low Speed]

#### ● Rolling Resistance at Low Speed

The data in the figure represent the test results of comparing rolling resistances at low speed between AFF Grease and other greases.

<Test conditions>

Item	Description
Model No.	HSR35RC0+440LP
Grease quantity	4cm <sup>3</sup> / LM block (initial lubrication only)
Feeding speed	1mm/s
Stroke	3mm

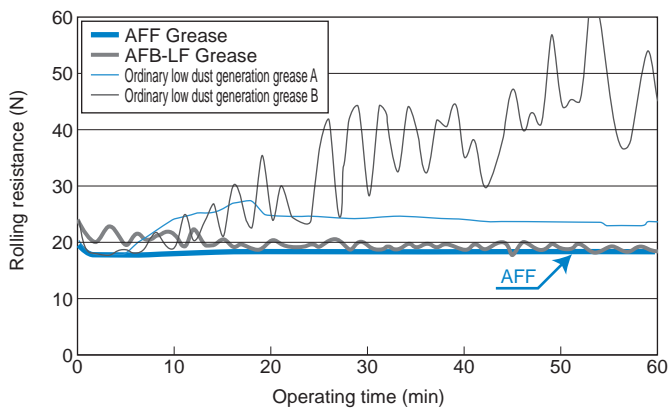

## THK Original Grease

# AFG Grease

- Base oil: high-grade synthetic oil
- Consistency enhancer: urea-based



AFG Grease is a high-grade grease for Ball Screws that uses a high-grade synthetic oil as the base oil and a urea-based consistency enhancer. It excels in low heat generation and supports a wide temperature range from low to high temperature.

### [Features]

- (1) Low heat generation  
Since the viscous resistance is low, the grease generates only a minimal level of heat even during high-speed operation.
- (2) Low viscosity  
Since the viscosity is low, a stable rotational torque is achieved.
- (3) Wide temperature range  
Maintains a high level of lubricity in a wide temperature range of  $-45^{\circ}\text{C}$  to  $+160^{\circ}\text{C}$ .
- (4) Long service life  
AFG Grease is not easily softened and excels in antioxidation stability even after a long-term operation.
- (5) Water resistance  
AFG Grease is a highly water resistant grease that is less vulnerable to moisture penetration and little decreases resistance to extreme pressure.

### [Representative Physical Properties]

Item	Representative value	Test method
Consistency enhancer	Urea-based	
Base oil	high-grade synthetic oil	
Base oil kinematic viscosity: $\text{mm}^2/\text{s}$ ( $40^{\circ}\text{C}$ )	25	JIS K 2220 23
Worked penetration ( $25^{\circ}\text{C}$ , 60W)	285	JIS K 2220 7
Mixing stability (100,000 W)	329	JIS K 2220 15
Dropping point $^{\circ}\text{C}$	261	JIS K 2220 8
Evaporation amount: mass% ( $99^{\circ}\text{C}$ , 22h)	0.2	JIS K 2220 10
Oil separation rate: mass% ( $100^{\circ}\text{C}$ , 24h)	0.5	JIS K 2220 11
Copper plate corrosion (B method, $100^{\circ}\text{C}$ , 24h)	Accepted	JIS K 2220 9
Low temperature torque: N-m ( $-20^{\circ}\text{C}$ )	Start	170
	(revolutions)	70
4-ball testing (burn-in load): N	3089	ASTM D2596
Service Temperature Range $^{\circ}\text{C}$	$-45$ to $160$	
Color	Brown	

### [Test Data on Low Heat Generation Characteristics]

#### ● Test Data on AFG Grease (Comparison of Heat Generation)

The test data in the figure represent the results of comparing heat generation between AFG Grease and other greases.

<Test conditions>

Item	Description
Shaft diameter/lead	32/10mm
Feeding speed	67 to 500mm/s
Shaft rotation speed	400 to 3000 min <sup>-1</sup>
Stroke	400mm
Grease quantity	12cm <sup>3</sup>
Temperature measurement point	Nut circumference

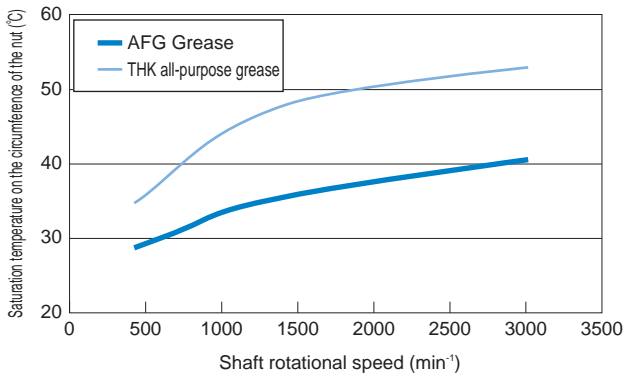

## THK Original Grease

# AFJ Grease

- Base oil: refined mineral oil
- Consistency enhancer: urea-based



The THK AFJ grease uses refined mineral oil as its base and contains urea-based consistency enhancer and other special additives that give excellent lubrication properties at a wide range of speeds, from low to high.

### [Features]

- (1) Wide range of speeds  
Provides consistent and even lubrication at both high and low work speeds.
- (2) Wear Resistance  
Even at low speeds, it has excellent oil film formation characteristics to reduce wear.
- (3) Resistant to vibration  
Reduces wear caused by machine vibration during high-speed operation.
- (4) Low rolling resistance  
Reduces rolling resistance in LM guides and ball screws over a wide range of speeds.

### [Representative Physical Properties]

Item	Representative value	Test method
Consistency enhancer	Urea-based	
Base oil	refined mineral oil	
Base oil kinematic viscosity: mm <sup>2</sup> /s (40°C)	20	JIS K 2220 23
Worked penetration (25°C, 60W)	325	JIS K 2220 7
Mixing stability (100,000 W)	360	JIS K 2220 15
Dropping point °C	185	JIS K 2220 8
Evaporation amount: mass% (99°C, 22h)	0.6	JIS K 2220 10
Oil separation rate: mass% (100°C, 24h)	7.0	JIS K 2220 11
Copper plate corrosion (B method, 100°C, 24h)	Accepted	JIS K 2220 9
Low temperature torque: N·m (-20°C)	Start	380
	(revolutions)	130
4-ball testing (burn-in load): N	3089	ASTM D2596
Service Temperature Range °C	-20 to 120	
Color	Yellowish brown	



### [Test data for LM guide block wear resistance]

#### ● AFJ grease test data (comparing the amount of wear)

The test data in the figure compares the test results for the amount of wear for this product and other greases.

<Test conditions>

Item	Description
Model No.	NRS55B2SS+780LP
Applied load	5.9kN
Feeding speed	0.1m/min
Stroke	200mm
Grease quantity	12cm/ LM block (initial lubrication only)
Test duration	480 hours

#### THK AFJ Grease

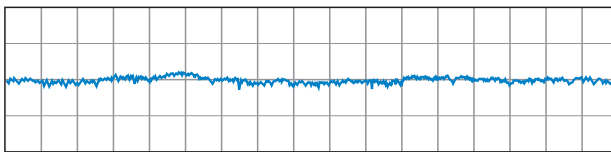

#### Other urea-based grease



### [Test data for LM guide rail vibration resistance]

#### ● AFJ grease test data (comparing the amount of vibration)

The test data in the figure compares the test results for the amount of vibration for this product and other greases.

<Test conditions>

Item	Description
Model No.	SHS25R1UU+580LP
Applied load	11.05 kN (0.35C)
Feeding speed	60 m/min
Acceleration/deceleration	9.8 m/s <sup>2</sup>
Stroke	350mm
Grease quantity	2 cm <sup>3</sup> /block

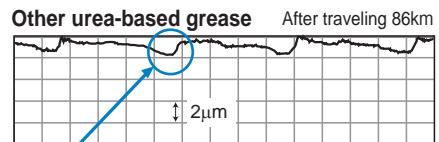
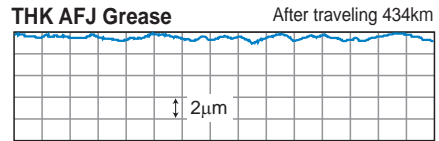

### "Wear Occurrence Mechanisms"

Patterns of high-speed and high acceleration/deceleration operation

Occurrence of machine vibration

Occurrence of wear in roll grooves

### [Measurement data for LM guide rolling resistance]

#### ● AFJ grease test data (rolling resistance comparison)

The test data in the figure compares the results of rolling resistance testing on this product and other greases.

<Test conditions>

Item	Description
Model No.	SHS25R1UU+3000L
Applied load	No load
Acceleration	29.4 m/s <sup>2</sup> (3G)
Stroke	2300mm
Test temperature	21 °C
Grease quantity	2 cm <sup>3</sup> /block
Measurement speed	0.5, 1, 2, 3, 4, 5, 6 m/s

### LM guide speeds and rolling resistance

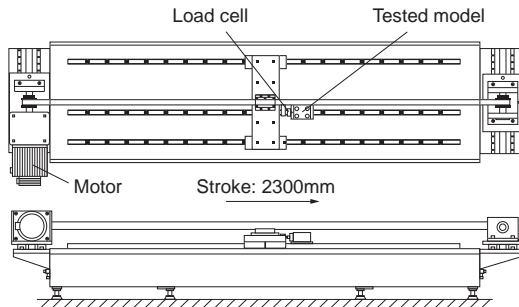
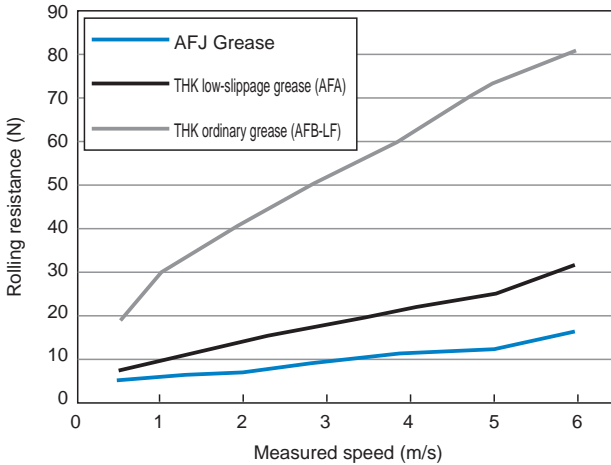

## Lubrication Equipment

# Grease Gun Unit MG70

● For detailed dimensions, see [A24-24](#).



Grease Gun Unit MG70 is capable of lubricating small to large types of LM Guides by replacing dedicated nozzles (attached). For small LM Guides, MG70 is provided with dedicated attachments. The user can select from these attachments according to the model number and the installation space.

MG70 has a slit window, allowing the user to check the remaining amount of grease.

It is equipped with a bellows cartridge that can hold 70 g of grease and is replaceable without smirching your hand. It supports a wide range of grease products, including AFA Grease, AFB-LF Grease, AFC Grease and AFE-CA Grease, to meet varied conditions. This enables you to make a selection according to the area requiring grease. (See [B24-7](#) to [B24-23](#).)

Grease not included with the MG70 Grease Gun Unit. Grease sold separately.

## Accessories for Lubrication

# Special Plumbing Fixtures

● For detailed dimensions, see [A24-25](#).

For centralized greasing and oil lubrication, special plumbing fixtures are available from THK. When ordering an LM system, specify the model number, mounting orientation and piping direction. We will ship the LM system attached with the corresponding fixture.

## Accessories for Lubrication

# Grease Nipple

● For detailed dimensions, see [A24-26](#).

THK provides various types of grease nipples needed for the lubrication of LM systems.

---

## Model Number Coding

---

Model number configurations differ depending on the model features. Refer to the corresponding sample model number configuration.

### [Grease Gun]

#### ● Model MG70

---

## MG70

(THK offers grease guns only for a 70g cartridge.)

---

### [THK Original Grease]

#### ● Models AFA, AFB-LF, AFC, AFE-CA, AFF, AFG and AFJ

---

●Type of packing···bellows cartridge

**AFC + 70**

Cartridge capacity (70 g / 400 g)

Type of grease (AFA Grease, AFB-LF Grease, AFC Grease, AFE-CA Grease, AFF Grease, AFG Grease, AFJ Grease)

---

